

Capacity of optical reading, Part 1: Reading boundless error-free bits using a single photon

Saikat Guha¹ and Jeffrey H. Shapiro²

¹Quantum Information Processing (QuIP) Group,
Raytheon BBN Technologies, Cambridge, Massachusetts 02138, USA

²Research Laboratory of Electronics, Massachusetts Institute of Technology, Cambridge, Massachusetts 02139, USA
(Dated: August 10, 2012)

We show that nature imposes no fundamental upper limit to the number of information bits per expended photon that can, in principle, be read reliably when classical data is encoded in a medium that can only passively modulate the amplitude and phase of the probe light. We show that with a coherent-state (laser) source, an *on-off* (amplitude-modulation) pixel encoding, and shot-noise-limited direct detection (an overly-optimistic model for commercial CD/DVD drives), the highest photon information efficiency achievable in principle is about 0.5 bit per transmitted photon. We then show that a coherent-state probe *can* read unlimited bits per photon when the receiver is allowed to make joint (inseparable) measurements on the reflected light from a large block of phase-modulated memory pixels. Finally, we show an example of a spatially-entangled non-classical light probe and a receiver design—constructable using a single-photon source, beam splitters, and single-photon detectors—that can in principle read any number of *error-free* bits of information. The probe is a single photon prepared in a uniform coherent superposition of multiple orthogonal spatial modes, i.e., a W-state. The code, target, and joint-detection receiver complexity required by a coherent-state transmitter to achieve comparable photon efficiency performance is shown to be *much* higher in comparison to that required by the W-state transceiver.

I. INTRODUCTION

Optical discs, such as CDs and DVDs, are ubiquitous. The surface of the CD contains a long spiral track of data, along which there are flat reflective areas called *land* and non-reflective *bumps* (see Fig. 1), representing binary 1 and binary 0, respectively. The drive shines a laser at the surface of the CD to read data. The photocurrent of the detector tracks the intensity of the reflected light, which the drive converts into estimates of 1s and 0s. There is an extensive literature and ongoing research on evaluation of information-theoretic capacities of optical storage, error-correcting codes, and techniques to make the storage and readout more efficient [1, 2]. The majority of this work, however, concentrates on what can be achieved by optimizing existing technology, as opposed to establishing what are the true ultimate limits on optical reading, as imposed by the laws of quantum physics.

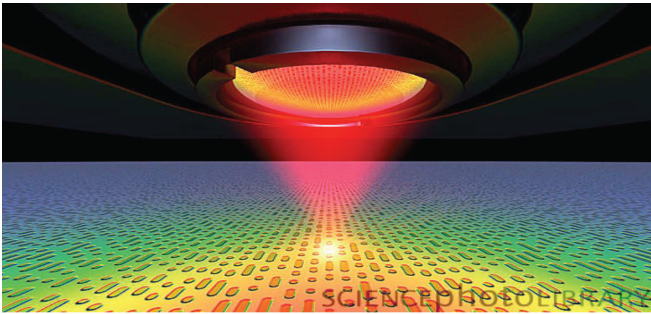

FIG. 1: Artist's impression of the read laser of a CD drive shining on the surface of an optical disc [picture courtesy: Science Photo Library].

Fundamentally, the performance of any optical communication or imaging system is limited by noise of quantum-mechanical origin, and optical reading of information is no exception. In order to delineate the ultimate performance of optical reading limited only by the laws of physics, an analysis within a full quantum-mechanical framework must therefore be done. In a suite of recent work by Pirandola and others [3–7], it has been shown that non-classical light paired with non-standard detection techniques can outperform a coherent-state (laser) probe to read data, i.e., the former can discriminate between a set of reflectivity-phase values of a pixel with a lower probability of error than the latter for a given transmitted-photon budget.

Lower error probability in discriminating signals from a modulation constellation does not automatically translate to increased *capacity*, i.e., the sustained reliable rate of reading that is achievable with an optimal modulation, code, and receiver. Attaining the quantum-limited capacity—the *Holevo limit* [8, 9]—requires joint detection receivers (JDRs), whenever the modulation constellation's quantum states are not mutually orthogonal. JDRs make collective measurements on the reflected light from many memory pixels—which cannot be realized by detecting the reflected light from each pixel individually—followed by optimal joint post-processing of all the (classical) measurement outcomes [10]. Recent work on capacity of optical reading [4] evaluated several achievable rates of reading that do employ JDRs over codewords and binary-amplitude pixel modulation, which however fall significantly short of the ultimate capacity and photon efficiency of optical reading when both amplitude and phase modulations are taken into account.

In this paper, we address the following fundamental

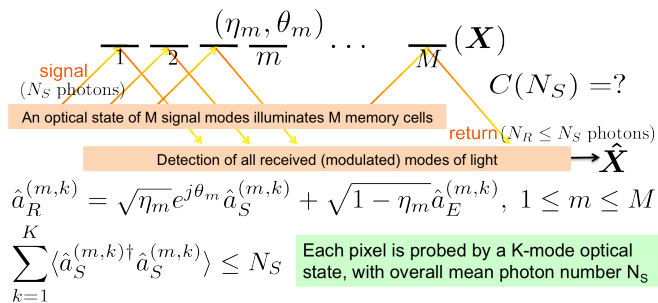

FIG. 2: Schematic of an optical memory that uses passive linear-optic reflective encoding. M memory pixels are shown. Each pixel can modulate the spatial mode of the incident probe light by a power attenuation $\eta_m \in [0, 1]$ and/or a (carrier) phase shift $\theta_m \in (0, 2\pi]$.

question. What is the ultimate upper limit to the number of bits of information that can be reliably read using an optical probe with a given mean photon-number budget when information is encoded using a reflective surface that can passively modulate a combination of the amplitude and phase of the probe light [12]? We show that there is no upper limit to the number of bits that can be read reliably per expended photon. We also show that with a coherent-state (laser) source, an *on-off* pixel modulation, and ideal direct detection (an overly-optimistic model for commercial CD/DVD drives), the highest photon information efficiency (PIE) achievable is about 0.5 bit per transmitted photon. We then show that a coherent-state probe can read boundless bits per transmitted photon when the receiver is allowed to make joint (collective) measurements on the reflected light from a large block of phase-modulated memory pixels. We show one structured design for such a JDR that can attain an unbounded PIE with a coherent-state transmitter, which is not possible using any conventional optical transceiver. Finally, we show an example of a spatially-entangled non-classical optical probe and an explicit receiver design—constructible using a single-photon source, beam splitters, and single-photon detectors—that in principle can read any number of *error-free* bits of information using a single transmitted photon. The probe is a single photon in a uniform superposition of multiple spatial modes, viz., a *W-state*.

II. CAPACITY OF OPTICAL READING

The setup we shall consider is shown in Fig. 2. Each memory pixel is a reflective surface that can modulate the incident optical mode(s) by a power attenuation factor $\eta_m \in [0, 1]$ and/or a (carrier) phase shift $\theta_m \in (0, 2\pi]$. A K -mode transmitter interrogates each memory pixel. Each pixel acts like a beam splitter, such that the return modes are given by $\hat{a}_R^{(m,k)} = \sqrt{\eta_m} e^{j\theta_m} \hat{a}_S^{(m,k)} + \sqrt{1-\eta_m} \hat{a}_E^{(m,k)}$, where the $\{\hat{a}_S^{(m,k)}\}$ are

the transmitter (signal) modes and the environment modes, $\{\hat{a}_E^{(m,k)}\}$, are taken to be in their respective vacuum states, implying no excess noise. We will impose a mean photon-number constraint on the transmitter, $(1/M) \sum_{k=1}^K \sum_{m=1}^M \langle \hat{a}_S^{(m,k)\dagger} \hat{a}_S^{(m,k)} \rangle \leq N_S$ photons per pixel. In what follows we will address the following two canonical questions:

1. **Capacity**—How many bits of information can be reliably read per memory pixel, $C(N_S)$ bits/pixel, as a function of the average photons spent to interrogate a pixel, N_S (with no constraints on the length of the code, the transmitter state and the receiver measurement)? We define photon information efficiency (PIE) as $C(N_S)/N_S$, the number of bits read per signal photon. As is true for most *capacities*, reading data at a rate $R < C(N_S)$ bits/pixel at a probability of word error $P_e^{(M)} \rightarrow 0$, may require coding over $M \rightarrow \infty$ many pixels and also a JDR over infinitely many pixels.
2. **Error exponent**—What is the minimum number of pixels M required (length of code and JDR) to attain a certain PIE, such that $P_e^{(M)} \leq \epsilon$?

For both of the preceding questions, we would also like to know whether, and by how much, can non-classical states of light and/or non-standard optical receivers (including JDRs) outperform a coherent-state (laser) probe and the standard optical receivers (homodyne, heterodyne and direct-detection). A more complete treatment of all these questions will be given in a longer version of Ref. [12], which will be written as a sequel to the present paper [13].

To focus on the fundamental aspects of the capacity and error-exponent questions, we will assume that there is: no return-path loss of the probe light (except for any loss due to amplitude modulation by the memory pixels); zero excess noise (such as noise due to detector imperfections or a thermal background); and a diffraction-limited transceiver with spatially-resolved pixels. There is a fundamental tradeoff between the photon efficiency (bits/photon) and the data rate (bits/sec) of optical reading. In this paper, we will focus on the high photon efficiency (low photon flux) regime. Finally, we will also limit our scope in this paper to a single-mode transmitter, i.e., $K = 1$.

We begin by considering an idealized model for the standard CD/DVD drive, i.e., a laser-light probe, on-off amplitude modulation, and a direct-detection receiver. A coherent state of the K modes $\{\hat{a}_S^{(m,k)}\}$, $1 \leq k \leq K$, interrogating pixel m can be treated as a single-mode coherent state. Interrogation and detection of each pixel induces a binary asymmetric channel shown in Fig. 3(a). The Shannon capacity [14] of this channel is given by:

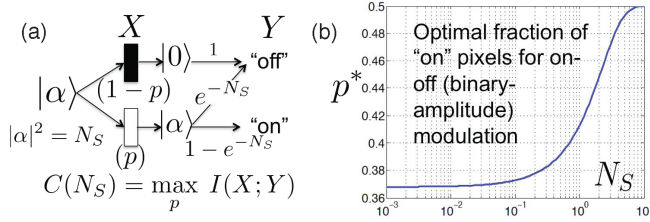

FIG. 3: (a) The induced binary channel for a coherent-state probe, on-off pixel encoding, and shot-noise-limited direct detection. (b) The optimal fraction of “on” pixels p^* that maximizes the number of bits read per pixel $C(N_S)$, when mean photon number N_S is used to interrogate each memory pixel.

$$C(N_S) = \max_{p \in (0,1)} I(X; Y) \quad (1)$$

$$= \max_{p \in (0,1)} [H(Y) - H(Y|X)] \quad (2)$$

$$= \max_{p \in (0,1)} [H(p(1 - e^{-N_S})) - pH(e^{-N_S})], \quad (3)$$

where $H(x) = -x \log_2 x - (1-x) \log_2 (1-x)$ is the binary entropy function. The optimal value of p that maximizes the mutual information $I(X; Y)$ is the fraction of “on” pixels in a capacity-achieving code, which is readily computed to be:

$$p^*(N_S) = \frac{1}{(1 - e^{-N_S}) \left[1 + 2^{H(e^{-N_S})/(1 - e^{-N_S})} \right]}. \quad (4)$$

Figure 3(b) shows that $p^*(N_S) \rightarrow 0.5$ for $N_S \gg 1$. This is the transmit power regime in which a standard CD drive operates, wherein optimal codes have equal fractions of *on* and *off* pixels. On the other hand, $p^*(N_S) \rightarrow 1/e \approx 0.368$ for $N_S \ll 1$. The solid blue line in Fig. 4 plots the PIE, $C(N_S)/N_S$, as a function of N_S for on-off pixel modulation, coherent-state probe, and direct detection. The PIE caps off, $C(N_S)/N_S \rightarrow 1/(e \ln 2) \approx 0.53$ bits per photon (bpp) for $N_S \ll 1$. Thus, even with the optimal code (codewords infinitely many pixels long), using on-off modulation, an ideal laser transmitter, and an ideal direct-detection receiver, no more than about 0.5 bit can be read per transmitted photon.

Let us now consider the binary phase-shift keyed (BPSK) modulation. Each memory pixel is a perfectly reflective pixel but some are etched $\lambda/2$ deeper into the surface of the disc, where λ is the center-wavelength of the (quasimonochromatic) probe light. A coherent-state probe $|\alpha\rangle$, $|\alpha|^2 = N_S$, sent to interrogate the m th pixel gets reflected as $|\alpha\rangle$ or $|\alpha\rangle$ depending upon whether that pixel’s phase is $\theta_m = 0$ or π . The conventional receiver to discriminate the states $\{|\alpha\rangle, |-\alpha\rangle\}$ uses homodyne detection, which results in a Gaussian-distributed measurement outcome $\beta \sim \mathcal{N}(\pm\alpha, 1/4)$, with mean $\pm\alpha$ and variance $1/4$. The minimum error-probability post-detection processor is the threshold test. $\beta \geq 0 \Rightarrow \theta = 0$ and $\beta < 0 \Rightarrow \theta = \pi$, which induces a binary symmetric channel (BSC) with crossover proba-

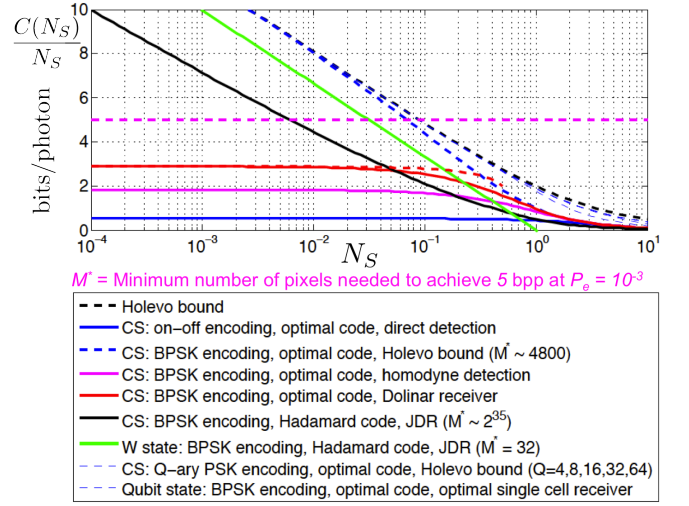

FIG. 4: Photon information efficiency (PIE) versus the mean photon number N_S used to interrogate each memory pixel. CS denotes coherent state.

bility $q_{\text{hom}} = \text{erfc}(\sqrt{2N_S})/2$ (see Fig. 5), whose capacity is given by $C(N_S) = 1 - H(q_{\text{hom}})$ bits/pixel, and is achieved for an equal prior ($p^* = 1/2$) for the two phase values. The minimum achievable error-probability for discriminating a single copy of the two equally-likely states $\{|\alpha\rangle, |-\alpha\rangle\}$ is given by the Helstrom limit [15], $P_{e,\text{min}} = \left[1 - \sqrt{1 - e^{-4N_S}} \right] / 2$. This minimum probability of error can in principle be achieved exactly using the Dolinar receiver [16, 17], which is a structured optical receiver design that uses a local time-varying optical feedback and high-speed ideal single-photon detection. The Dolinar receiver used with BPSK modulation induces a BSC with crossover probability $q_{\text{min}} = P_{e,\text{min}}$, and capacity $C(N_S) = 1 - H(q_{\text{min}})$ bits/pixel. The magenta and red plots in Fig. 4 show the PIE for BPSK encoding with the homodyne and Dolinar receivers, which cap off at $4/(\pi \ln 2) \approx 1.84$ bpp and $2/\ln 2 \approx 2.89$ bpp, respectively, for $N_S \ll 1$.

For a single $\{0, \pi\}$ binary phase-modulated pixel, of all (multimode) transmitter states with mean photon number N_S , the one that minimizes the probability of error is the single-mode ($K = 1$) *single-rail encoded* qubit state, $|\psi\rangle^S = \sqrt{1 - N_S}|0\rangle + \sqrt{N_S}|1\rangle$, which attains zero probability of error for $N_S \geq 1/2$, and $P_{e,\text{min,QS}} = \left[1 - \sqrt{1 - [1 - 2N_S]^2} \right] / 2$, for $N_S < 1/2$ [7]. Capacity is again given by the BSC capacity formula, $C(N_S) = 1 - H(P_{e,\text{min,QS}})$ bits/pixel (see the red-dashed plot in Fig. 4). The resulting PIE caps off at $2/\ln 2 = 2.89$ bpp for $N_S \ll 1$. Note that the BPSK pixel modulation format achieves the minimum possible probability of error over all transmitters and receivers acting on reflection from single pixels, and hence achieves higher capacity (and PIE) than what can be obtained via amplitude modulation alone [4]. Notwithstanding, the PIE of all the cases considered above cap off below 3 bpp.

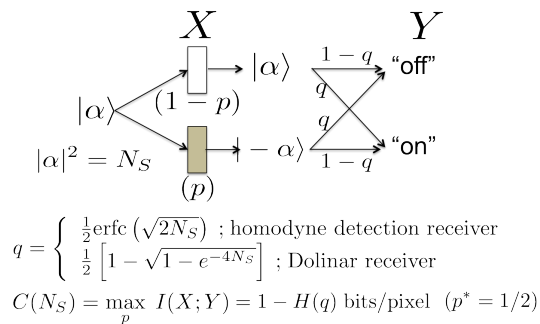

FIG. 5: A binary symmetric channel is induced when a coherent state probe $|\alpha\rangle$ interrogates each memory pixel, and the reflected light is detected by either a conventional homodyne receiver with a threshold detector, or by the Dolinar receiver—a receiver that can attain the minimum probability of error for discriminating between two coherent states.

The classical information-carrying (Holevo) capacity of a quantum signaling alphabet was found by Holevo, Schumacher and Westmoreland [8, 9]. The Holevo capacity of the pure-loss (vacuum-noise) optical channel with a mean received photon number per mode N_S is given by $g(N_S)$ bits/mode, where $g(x) = (1+x) \log_2(1+x) - x \log_2(x)$ [20]. This capacity is achievable using a coherent-state code with symbols $|\alpha\rangle$ chosen in an independent, identically-distributed (i.i.d.) manner from the isotropic Gaussian distribution, $p(\alpha) = e^{-|\alpha|^2/N_S}/\pi N_S$. Hence, for communicating classical data on a pure-loss optical channel, non-classical transmitter states cannot achieve any higher capacity than coherent states. From the capacity theorem converse in [20]—treating the reflected light from the memory pixels as a modulated codeword—and monotonicity of the $g(\cdot)$ function, the capacity of optical reading must satisfy the upper bound, $C(N_S) \leq g(N_S)$, for all single-mode probe states ($K = 1$). However, the reading problem has less encoding freedom than the communication transmitter, because its modulation must be passive (non-amplifying) at the pixels. That is why $C(N_S) = g(N_S)$ bits/pixel is not achievable for optical reading using a coherent-state transmitter [13]. However, we showed that $C(N_S) = g(N_S)$ bits/pixel *is* achievable using a non-classical transmitter [12, 13] and a sequential-decoding quantum joint-detection receiver [18].

The black-dashed line in Fig. 4 shows the PIE of the Holevo bound $g(N_S)/N_S$. Note that, unlike all the capacity results for on-off and binary-phase modulation with explicit pixel-by-pixel detection schemes considered above, the Holevo bound has no upper limit to the number of bits that can be read per expended photon. However, the higher the desired PIE, the lower must be the mean photon number N_S used to interrogate each pixel, resulting in a lower data rate $C(N_S)$ (bits/pixel) read. We now show that even though coherent states cannot attain the Holevo bound exactly, in the high-PIE ($N_S \ll 1$) regime, the Holevo capacity achievable using a coherent-

state probe (albeit with the optimal JDR that makes a collective measurement over return modes from many pixels) comes exceedingly close to the Holevo bound $g(N_S)$, using phase-only modulation. The blue-dashed plots in Fig. 4 are the Holevo-limit PIEs of Q -ary phase-shift-keying (PSK) constellations used to encode the data for $Q = 2, 4, 8, 16, 32$. Because the PSK Holevo limit for any Q is an achievable rate [9], it is a lower bound to the reading capacity, i.e., $C(N_S) \geq C_{\text{PSK-Holevo}}(N_S)$, where

$$C_{\text{PSK-Holevo}}(N_S) = \max_{Q \geq 2} \frac{1}{Q} \sum_{q=1}^Q y_q(N_S) \log_2 y_q(N_S),$$

with $\{y_q(N_S)\}$, $1 \leq q \leq Q$, being the probability distribution,

$$y_q(N_S) = \frac{1}{Q} \sum_{k=1}^Q e^{-N_S(1 - \cos[\frac{2\pi k}{Q}])} \cos \left[N_S \sin \left[\frac{2\pi k}{Q} \right] - \frac{2\pi k q}{Q} \right].$$

For $Q = 2$ (BPSK modulation), the Holevo capacity is given by $C_{\text{BPSK}}(N_S) = H((1 + e^{-2N_S})/2)$ bits/pixel. Its PIE is shown by the dark dashed-blue plot in Fig. 4, where it is seen to approach the Holevo limit $g(N_S)/N_S$ at low N_S . Thus, the gap between the PIE of BPSK modulation used with an optimal single-symbol receiver (solid-red plot) and the Holevo limit of BPSK (dashed-blue plot) must be bridged using JDRs.

The first concrete example of a code-JDR pair for a BPSK alphabet that achieves *superadditive* capacity (i.e., higher capacity than what is achievable with the optimal single-symbol receiver for BPSK) was found by one of us recently in the context of a communication receiver [10]. The same applies for optical reading. The Green Machine JDR for BPSK-modulated pixels and a coherent-state probe is depicted in Fig. 6. It uses a $(2^m, 2^m, 2^{m-1})$ binary Hadamard code to encode the binary phases on $M = 2^m$ pixels. The receiver comprises an interferometer made of $(M \log_2 M)/2$ 50-50 beam splitters arranged in a format—first envisioned by R. R. Green as a classical decoding circuit for Hadamard codes [11]—that interferometrically mixes the modulated light from the M pixels, transforming the BPSK Hadamard codeword, through $\log_2 M$ stages of the Green Machine, into a spatial pulse-position-modulation (PPM) code. A coherent-state pulse with mean photon number MN_S appears at one of the M outputs, depending upon which of the M -pixel Hadamard codewords the probe light interrogates. The output is detected by an array of M signal-shot-noise-limited single-photon detectors. This probe-code-JDR combination induces an M -input, $M + 1$ -output superchannel, shown in Fig. 7, whose capacity (in bits/pixel)

is given by:

$$\begin{aligned}
 C_{\text{BPSK-Hadamard-JDR}}(N_S) &= \max_{M \geq 2} \frac{I(X; Y)}{M} \quad (5) \\
 &= \max_{M \geq 2} \frac{(\log_2 M) (1 - e^{-MN_S})}{M} \\
 &= \frac{1}{\ln 2} \left[N_S \ln \frac{1}{N_S} - N_S \ln \ln \frac{1}{N_S} + \dots \right] \text{ bits/pixel,}
 \end{aligned}$$

when $N_S \ll 1$. Here, the PIE-maximizing value of the code size M as a function of N_S is given by $M^* \approx -5/2N_S \ln N_S$, for $N_S \ll 1$. This PIE is plotted as the solid-black line in Fig. 4. Unlike all the structured probe-receiver cases we have considered so far—in which the optical receiver measured the reflected light from each pixel individually—the PIE attained by the BPSK Hadamard code and the Green Machine JDR increases without bound as $N_S \rightarrow 0$. Note that this PIE is optimal to the first leading-order term of the Holevo bound (both the unrestricted-modulation Holevo bound and the coherent-state-probe BPSK-encoding Holevo capacity):

$$C(N_S) = \frac{1}{\ln 2} \left[N_S \ln \frac{1}{N_S} + N_S + \dots \right] \text{ bits/pixel,} \quad (6)$$

for $N_S \ll 1$. One can increase the photon efficiency slightly by using the $(2^m - 1, 2^m, 2^{m-1})$ Hadamard code, thereby using one less ($M = 2^m - 1$) pixel, and retaining a local-oscillator reference at the transmitter for use as a local input into the Green Machine. Note that the achievable capacity in Eq. (5) and all the coherent-state structured-receiver capacities given above are Shannon capacities of the respective discrete memoryless channels induced by the choice of the probe-(code)-receiver combination. Hence, in order to achieve error-free reading at a rate close to these capacities (in bits/pixel), a suitable Shannon-capacity-approaching outer code—such as a Reed Solomon code—will be required.

Now, let us keep the same (BPSK) modulation and code (Hadamard) as the previous example, but consider a spatially-entangled non-classical probe state, the W-state. This probe sends exactly one photon in a coherent superposition of M spatial modes (so as to interrogate M memory pixels):

$$|W_M\rangle \equiv \frac{|10\dots 0\rangle + |01\dots 0\rangle + \dots + |00\dots 1\rangle}{\sqrt{M}}, \quad (7)$$

which can be prepared using a single-photon source (generating a one-photon Fock state $|1\rangle$) split via an array of 50-50 beam splitters as shown in Fig. 8. Recently, it was shown how to perform fast heralded generation of the W-state, and other complicated mode-shaped single photon states, by indirectly tailoring the mode of the single photon via amplitude modulation of the classical pump field driving a spontaneous parametric downconversion process [19]. Reflection of the W-state by the Hadamard-phase-coded pixels causes the ‘+’ signs in the W-state superposition corresponding to the pixels with $\theta = \pi$ to flip

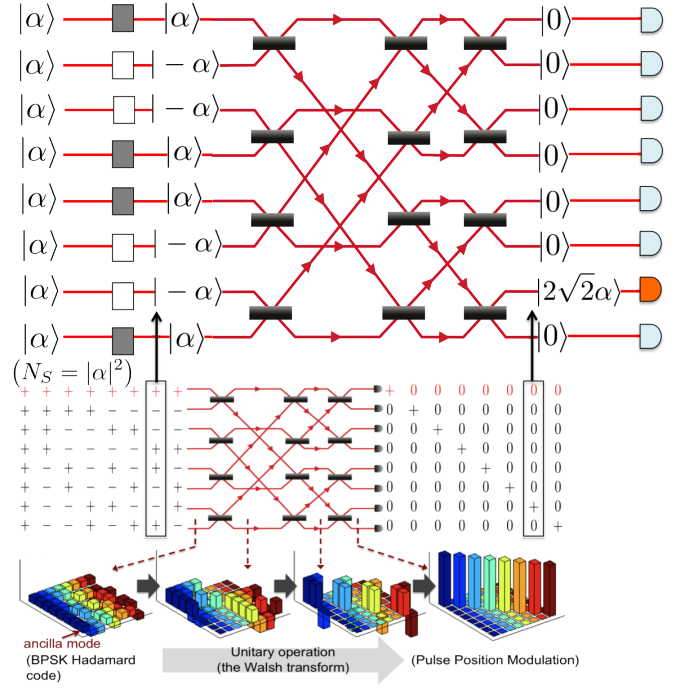

FIG. 6: The Green Machine JDR. Each vertical column of ‘+’s and ‘-’s is a reflection from M binary-phase-coded memory pixels—a coherent-state BPSK codeword from the Hadamard code with M pulses of mean photon number N_S each. Each of the M codewords transforms into exactly one coherent state of mean photon number MN_S at one distinct output port of the optical circuit of $(M \log_2 M)/2$ beam splitters. Under ideal conditions, a click at one of the M single-photon detectors identifies the reflected codeword with no error, whereas a no-click leads to an *erasure* outcome, which induces the M -ary symmetric erasure channel shown in Fig. 7.

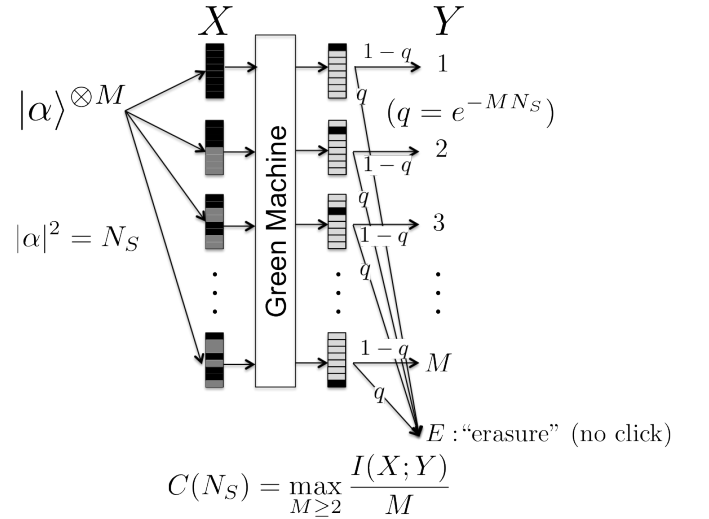

FIG. 7: An M -input, $M + 1$ -output channel induced by the coherent-state probe, binary-phase Hadamard coded memory, and the Green Machine JDR.

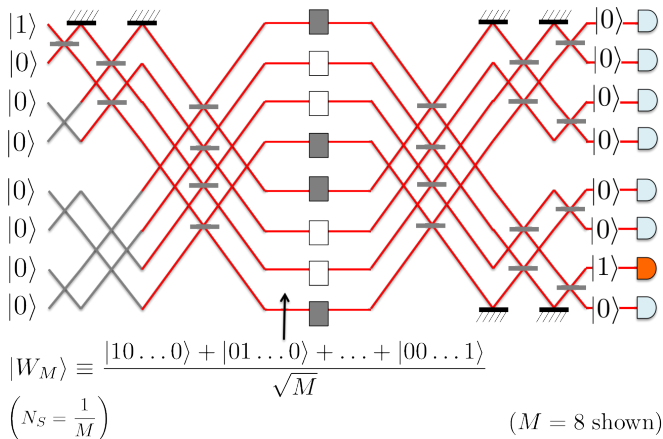

FIG. 8: The W-state transmitter, generating the $M = 8$ mode W state, interrogates M binary-Hadamard phase-coded pixels. The wave function of the single photon evolves through the receiver stages, eventually coalescing into the single-photon Fock state $|1\rangle$ at one of the M outputs of the receiver, depending upon which one of the M Hadamard codewords the transmitter state interrogated.

to ‘-’ signs. Let the memory-modulated state for codeword m be $|W_M^{(m)}\rangle$, for $1 \leq m \leq M$. Because any pair of codewords from the Hadamard code differ in exactly half ($M/2$) the positions, the $\{|W_M^{(m)}\rangle\}$ are mutually orthogonal quantum states; i.e., $\langle W_M^{(m_1)} | W_M^{(m_2)} \rangle = \delta_{m_1, m_2}$. Therefore, it is possible, in principle, to discriminate these M modulated states with zero probability of error. An explicit receiver that accomplishes this zero-error discrimination is shown in Fig. 8. The wave function of the single photon evolves through the $\log_2 M$ receiver stages, eventually coalescing into the single-photon Fock state $|1\rangle$ at one of the M outputs of the beam splitter circuit depending upon which one of the M Hadamard codewords the transmitter state interrogated. A single-photon Fock state $|1\rangle$ generates a click with probability 1 when detected by an ideal single-photon detector (unlike a coherent state $|\beta\rangle$, which generates a click with probability $1 - e^{-|\beta|^2}$ under ideal conditions). Therefore, the W-state transceiver reads $\log_2 M$ bits of information *error-free* (and without any further outer coding) using just one transmitted photon, with no upper limit on M . Clearly, $N_S = 1/M$. Therefore, capacity is given by:

$$C_{W\text{-state}}(N_S) = N_S \log_2 \frac{1}{N_S} \text{ bits/pixel.} \quad (8)$$

Note that this capacity has the same leading-order term as the Holevo limit and the coherent-state Green Machine JDR. The PIE for the W-state is exactly $\log_2(1/N_S)$ bpp, i.e., a straight line when plotted versus N_S on a logarithmic scale (see the green line in Fig. 4). Figure 9 shows an $M = 64$ example of the single photon’s probability-amplitude evolution during the encoding and decoding phases of optical reading using a W-state.

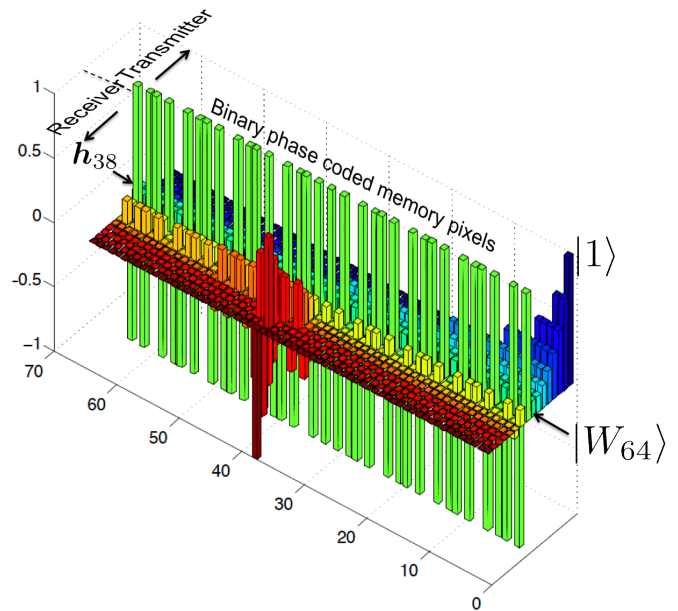

FIG. 9: An $M = 64$ example of W-state probability-amplitude evolution during the encoding and decoding phases of optical reading. The vertical axis denotes the amplitude and (binary) phase of the photon wave function. Positive (upwards from 0) denotes 0-phase and negative (downwards from 0) denotes π -phase. The green vertical bars depict the 38th of the BPSK Hadamard codewords, h_m , $1 \leq m \leq 64$, using the above sign-convention for 0 and π phases. A single-photon Fock state $|1\rangle$ is shown to go through the $\log_2 M = 8$ stages of the encoding circuit, shown in Fig. 8, to form the equal-superposition W-state $|W_{64}\rangle$, which undergoes phase-modulation at the memory pixels (green bars). The modulated W-state is shown to go through the 8 stages of the optical receiver circuit, also shown in Fig. 8, eventually forming a single-photon Fock state $|1\rangle$ (with an unimportant phase) at the correct (38th) output port, which is then detected error-free by an ideal single-photon detector.

III. ERROR EXPONENT OF QUANTUM READING

All the results obtained in Section II are (Holevo or Shannon) capacities. Thus, achieving a reliable rate of reading (i.e., reading information such that the probability of codeword error $P_e^{(M)} \leq \epsilon$ for some low-enough threshold ϵ) at any given rate $R < C(N_S)$ bits/pixel would require an optimal outer code (for all the Shannon-capacity/structured-receiver cases considered), and would require an optimal code as well as an optimal JDR (for the Holevo-capacity results). The W-state example does not require an outer code, because of its zero-error receiver.

Reading capacity gives a crucial information-theoretic perspective, namely, the fundamental limit on achievable rates at which data can be read. However, capacity alone

only specifies the maximum achievable rate. It provides no information about the coding and receiver complexity required to read data reliably at any achievable rate. Hence, a stronger form of the channel coding theorem has been pursued to determine the behavior of the minimum codeword-error probability, $P_e^{(M)}$, as a function of the codeword length (number of pixels) M and the data rate R (bits/pixel), for all rates $R < C$ —both for classical channels (where C is the channel’s Shannon capacity) [21, 22] as well for quantum channels (where C is the channel’s Holevo capacity) [23, 26]. We define the reliability function or the *error exponent* for optical reading as [21],

$$E(R) \equiv \limsup_{M \rightarrow \infty} \frac{-\ln P_e^{\text{opt}}(R, M)}{M}, \forall R < C(N_S), \quad (9)$$

where $P_e^{\text{opt}}(R, M)$ is the average block error probability for the optimal block code of M pixels and rate R . The error exponent describes how quickly the error probability decays as a function of M , and hence serves to indicate how difficult it may be to achieve a certain level of reliability in reading at a given rate below the capacity. Although it is difficult to exactly evaluate $E(R)$, its classical lower bound is available due to Gallager [22]. This lower bound to the error exponent is known as the random-coding lower bound, and has been used to estimate the codeword length required to achieve a prescribed error probability for various communication settings. Burnashev and Holevo found the random-coding bound and the expurgated bound for sending classical data on quantum channels, both being lower bounds to $E(R)$ for a pure-state alphabet [23], and later generalized the expurgated bound to a mixed-state alphabet [24]. The best known lower bound to the quantum channel’s reliability function $E(R)$ was reported by Hayashi [25]. For classical channels, there exists an upper bound (the sphere-packing bound) which coincides with $E(R)$ for high rates, i.e., for rates R close to the Shannon capacity, C , and thus gives the exact expression for $E(R)$. Until very recently, no useful upper bound for $E(R)$ had been known for the quantum case. That changed, however, when Dalai reported the sphere-packing bound for the error exponent for sending classical data on a quantum channel [26]. Dalai’s upper bound to $E(R)$ for the quantum channel coincides with the random-coding lower bound at high rates, thereby yielding the true value of $E(R)$ in this region. More work needs to be done in the low-rate regime, in order to fully determine the error exponent $E(R)$ for a quantum channel for all rates R below the Holevo capacity.

In order to compare the error-exponent performance of various transceivers we proposed in Section II, let us choose a PIE goal of 5 bpp, and probability of word error threshold $\epsilon = 10^{-3}$.

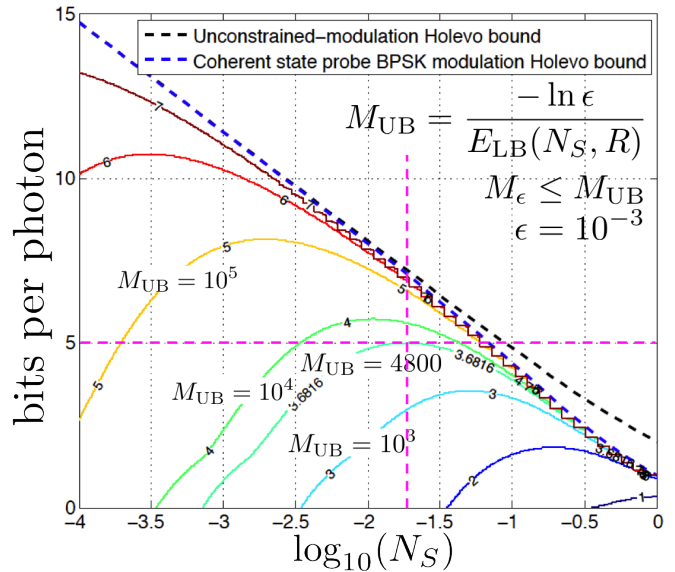

FIG. 10: Contours of constant $M_{\text{UB}} \equiv -\ln \epsilon / E_{\text{LB}}(N_S, R)$ —the upper bound to the number of pixels required to achieve 5 bpp with a 10^{-3} word-error probability found from the Burnashev-Holevo random-coding bound for a pure-state quantum channel—plotted in the PIE (R/N_S) vs. N_S plane. A coherent-state probe interrogating a binary-phase coded memory and an optimal JDR are assumed.

A. Coherent-state probe: optimal code, optimal JDR

We now estimate the number of pixels M required to meet 5 bpp with $P_e^M = 10^{-3}$ using a coherent-state transmitter and the optimum code-JDR pair. We evaluate the Burnashev-Holevo lower bound to the error exponent, $E_{\text{LB}}(N_S, R) \leq E(N_S, R)$, for the states $\{|\alpha\rangle, |-\alpha\rangle\}$, $|\alpha|^2 = N_S$, $\langle -\alpha|\alpha\rangle = e^{-2N_S}$ (Section 4 of Ref. [23]). Figure 10 shows contours of constant $M_{\text{UB}} \equiv -\ln \epsilon / E_{\text{LB}}(N_S, R)$ in the PIE (R/N_S) vs. N_S plane for $\epsilon = 10^{-3}$. At $R/N_S = 5$ bpp, we find that $M_{\text{UB}} = 4800$. Therefore, in order to attain 5 bpp at $P_e^{(M)} \leq 10^{-3}$, the minimum number of pixels required satisfies $M \leq 4800$. Given that the rate is about 2/3 of capacity at the point where 5 bpp is barely reached (see the dashed magenta lines in Fig. 10), the random-coding bound is likely to be a fairly good estimate of the actual number of pixels required for an optimal code-JDR pair.

B. Coherent-state probe: Hadamard code, Green Machine JDR

The probability of word error for this probe-code-JDR combination is given by the probability of erasure times the probability the erasure is mapped to an incorrect codeword, $P_e^{(M)} = (M-1)e^{-MN_S}/M$. It follows that the PIE obeys $C(N_S)/N_S = (\log_2 M) (1 - e^{-MN_S}) / (MN_S)$

bpp, from which it is easy to deduce that achieving 5 bpp at $P_e^{(M)} \leq 10^{-3}$, will require $M \approx 2^{35}$ pixels. This pixel number is orders of magnitude higher than what is required by the optimal code-JDR pair.

C. W-state transmitter: Hadamard code, W-state JDR

The W-state transmitter, along with a Hadamard binary-phase code, and the JDR shown in Fig. 8, can read $\log_2 M$ bits using one transmitted photon at $P_e^{(M)} = 0$. Therefore, to achieve 5 bpp, at $P_e^{(M)} \leq 10^{-3}$, an $M = 32$ pixel memory suffices. This demonstrates the *huge* error-exponent benefit enjoyed by a quantum (spatially-entangled) transmitter in comparison with the coherent-state probe—even when the (as yet unknown) optimal JDR for a capacity-achieving coherent-state code may become available.

IV. CONCLUSION AND DISCUSSION

We showed that using a coherent-state (laser) probe, an on-off amplitude modulation, and signal-shot-noise-limited direct detection (a highly optimistic model for conventional CD/DVD drives), one cannot read any more than about 0.5 bits per transmitted photon. We then showed that a coherent-state transmitter, in conjunction with a binary-phase-shift-keyed (BPSK) encoding, can read an unlimited number of bits reliably per expended photon, if non-standard joint-detection measurements are allowed at the receiver. This capacity performance of coherent states approaches the Holevo bound to capacity in the high photon-information-efficiency (PIE) low-photon-flux regime. However, with a coherent-state source and binary phase encoding, if the receiver is constrained to detect the reflected light from each memory pixel one at a time followed by classical signal processing—all conventional optical receivers fall in this category—then the highest photon efficiency achievable caps off at about 2.89 bits per photon. Thus, joint detection receivers (JDRs) are needed to bridge the gap to the Holevo capacity, which allows for unbounded photon efficiency of optical reading. We exhibited one example of a BPSK code-JDR pair that can bridge part of that gap, and attain an unbounded PIE. However, this example has a poor error-exponent performance. In particular, in order to attain 5 bpp at a probability of word error $P_e^M \leq 10^{-3}$, it requires coding over $M \approx 2^{35}$ memory pixels, unlike the $M \approx 4800$ pixels required by the (unknown) optimal code-JDR pair to attain 5 bpp and $P_e^M \leq 10^{-3}$ with a coherent-state probe and BPSK modulation. Finally, we showed that a non-classical W-state probe can read $\log_2 M$ bits of data using a single photon in an M -mode spatially-entangled uniform-superposition state, with a BPSK Hadamard code, and

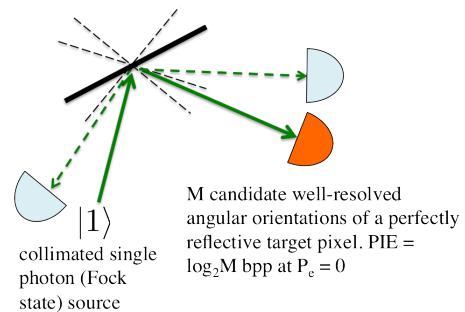

FIG. 11: M angular positions of a perfectly-reflective mirror can encode $\log_2 M$ bits of information that can be read error-free, in principle, by a well-collimated single-photon Fock state source, and an array of unity-detection-efficiency single-photon detectors.

a structured interferometric receiver that uses a linear-optical circuit of beam splitters and single-photon detectors. This transceiver can attain 5 bpp and $P_e^M \leq 10^{-3}$ (in fact, $P_e^{(M)} = 0$) with just $M = 32$ pixels, demonstrating the huge error-exponent advantage afforded by a quantum transmitter state.

That the W-state transmitter can read any number of bits of information using just one photon should come as no surprise. Consider the thought experiment shown in Fig. 11. A perfectly-reflective mirror encodes information using M well-resolved angular orientations, such that a well-collimated single-photon beam, reflected by the mirror, is detected via an array of single-photon detectors, one matched to each of the mirror's angular positions. Like the W-state transceiver, this arrangement reads $\log_2 M$ bits of information using one probe photon. These angular well-resolved orthogonal modes can be replaced by any set of M orthogonal space-time-polarization modes of light that the target (memory) can excite using the incident single-photon state. For the W-state example, the orthogonal modes the spatially-entangled photon excites are a set of spatially-overlapping mutually-orthogonal spatial modes corresponding to the binary Hadamard codewords. This is quite similar to the mutually-orthogonal chip waveforms of a spread-spectrum code-division multiple-access (CDMA) system.

Before concluding, it is in order to comment briefly on the effect that loss has on optical reading. In a practical setting, loss would be incurred at various points in the reading setup: at the transmitter that generates the probe light, in the transmission to the memory pixel, in absorption and scattering of the probe light at the pixel, in collecting the reflected light at the receiver, and in the sub-unity quantum efficiency of the single-photon detector. It turns out that the capacities of all the coherent-state systems we have considered in this paper degrade gracefully with loss, i.e., these capacities have the same formulas as given in the paper for no loss with the average number of transmitted photons N_S replaced by the aver-

age number of detected photons κN_S , where $1 - \kappa \in (0, 1]$ is the end-to-end loss. Furthermore, the number of pixels M needed to get a desired number of bits per *detected* photon for a given word-error probability does not change from what we found for the lossless case. For the W-state system, however, the behavior is very different. The W-state system will have an erasure probability equal to $1 - \kappa$. Assuming we randomly assign a codeword to every erasure, we are left with a word-error probability $P_e^{(M)} = (1 - \kappa)(M - 1)/M \approx 1 - \kappa$, for $M \gg 1$. Thus, to get to 5 bpp with $P_e^{(M)} \leq 0.001$, we need to have $\kappa \geq 0.999$, an extraordinarily demanding task considering that single-photon detectors with 99.9% quantum efficiency have yet to be built and there are many other sources of loss in the optical reading setup. Alternatively, we could decline to assign a codeword to an erasure and then repeat W-state transmission until we got a click. In this case, a click at a detector would still read boundless number of error-free bits, albeit with $1/\kappa$ transmitted photons on average. Then, because losses in fabricating the linear-optic circuit might increase as M increases, the question becomes whether we can truly read a boundless number of bits decoded per photon from the W-state system. Finally, an interesting thing to note is that our W-state system is a special case of the Aaronson-Arkhipov (AA) boson-sampling model [30], which inputs independent single photons occupying $\sim\sqrt{M}$ modes into an M -mode passive linear-optic circuit, followed by ideal photon counting on the outputs of the mode transformation device. The AA model was shown to be able to efficiently solve a sampling problem that is closely related to the computation of the permanent of a matrix, a problem known to be classically hard. The AA model is however not known to subsume universal quantum com-

putation. A recent paper reported evidence towards the fact that even a lossy AA system, or AA systems with mode mismatch in the linear-optic mode transformation device, are likely to be classically hard to simulate, and thus retain some of their quantum power [31].

In Ref. [13], we will address the capacity of optical reading at all values of the probe photon number constraint N_S . We will see that not only do quantum probes achieve a higher error exponent, they can get a fundamentally higher capacity in the high spectral efficiency ($N_S \gg 1$) regime. In Ref. [13], we will also consider the capacity of assisted reading, i.e., when the transmitter retains idler modes $\{\hat{a}_I^{(m,k)}\}$ at the transmitter, entangled with the signal modes $\{\hat{a}_S^{(m,k)}\}$ that are sent towards the pixel, followed by joint detection over several idler and return modes. The ultimate capacity and error-exponent performance of multi-mode transmitters remain subjects of ongoing work.

V. ACKNOWLEDGEMENTS

The authors thank Ranjith Nair, Brent J. Yen, Zachary Dutton, Mark M. Wilde, Stefano Pirandola and Jonathan L. Habif for useful discussions. The authors thank Marco Dalai, Stefano Pirandola, and Peter P. Rohde for useful comments on a draft. SG was supported by the DARPA Information in a Photon (InPho) program under contract number HR0011-10-C-0162. The views and conclusions contained in this document are those of the authors and should not be interpreted as representing the official policies, either expressly or implied, of the Defense Advanced Research Projects Agency or the U.S. Government. JHS acknowledges support from the ONR Basic Research Challenge Program.

-
- [1] K. Censor and T. Etzion, “The positive capacity region of two-dimensional run length constrained channels”, Proc. of IEEE Int. Symp. on Inf. Th. (ISIT), July 9–14, Seattle (2006).
 - [2] D. Carter, “High density data storage: Principle, technology, and materials”, *Platinum Metals Rev.* **54**, 1, 53 (2010).
 - [3] S. Pirandola, *Phys. Rev. Lett.* **106**, 090504 (2011).
 - [4] S. Pirandola, C. Lupo, V. Giovannetti, S. Mancini, and S. L. Braunstein, *New J. Phys.* **13**, 113012 (2011).
 - [5] O. Hirota, “Error free Quantum Reading by Quasi Bell State of Entangled Coherent States”, arXiv:1108.4163v2 [quant-ph] (2011).
 - [6] R. Nair and B. J. Yen, *Phys. Rev. Lett.* **107**, 193602 (2011).
 - [7] R. Nair, B. J. Yen, S. Guha, J. H. Shapiro, S. Pirandola, arXiv:1206.0673v1 [quant-ph], *Phys. Rev. A*, to appear, (2012).
 - [8] A. S. Holevo, *Problemy Peredachi Informatsii*, **15**, 3 [Problems of Information Transmission (USSR)] **15**, 247 (1979).
 - [9] P. Hausladen, R. Jozsa, B. Schumacher, M. Westmoreland and W. K. Wootters, *Phys. Rev. A* **54**, 1869 (1996).
 - [10] S. Guha, *Phys. Rev. Lett.* **106**, 240502 (2011).
 - [11] R. R. Green, “A serial orthogonal decoder”, JPL Space Programs Summary No. 37–39, Vol. IV, (1966); “Analysis of a serial orthogonal decoder”, JPL Space Programs Summary No. 37–53, Vol. III, (1968).
 - [12] S. Guha, Z. Dutton, R. Nair, J. H. Shapiro, and B. J. Yen, “Information capacity of quantum reading”, *OSA Frontiers in Optics*, (2011).
 - [13] S. Guha, R. Nair, B. J. Yen, Z. Dutton, and J. H. Shapiro, “Capacity of optical reading, Part 2: Attaining capacity using non-classical transmitters,” *in preparation*, (2012).
 - [14] C. E. Shannon, “A mathematical theory of communication,” *Bell Syst. Tech. J.*, vol. **27**, pp. 379–423, 623–656, July–Oct. (1948).
 - [15] C. W. Helstrom, *Quantum Detection and Estimation Theory*, Academic Press, New York (1976).
 - [16] S. J. Dolinar, Ph.D. thesis, MIT (1976).
 - [17] R.L. Cook, P.J. Martin, and J.M. Geremia, “Optical coherent state discrimination using a closedloop quantum measurement,” *Nature* **446**, 774, (2007).
 - [18] M. M. Wilde, S. Guha, S.-H. Tan, and S. Lloyd, “Ex-

- PLICIT capacity-achieving receivers for optical communication and quantum reading”, Proc. of the International Symposium on Information Theory (ISIT 2012), Cambridge, MA, arXiv:1202.0518v1 [quant-ph] (2012).
- [19] K. G. Köprülü, Y.-P. Huang, G. A. Barbosa, and P. Kumar, “Lossless single-photon shaping via heralding”, *Optics Lett.*, **36**, No. 9, May 1, (2011); K. G. Köprülü, G. A. Barbosa, and P. Kumar, “Quantum imaging of nonlocal spatial correlations in parametric down-conversion induced by the pump-beam profile”, Quantum Electronics and Laser Science Conference (QELS), Baltimore, MD (2005).
- [20] V. Giovannetti, S. Guha, S. Lloyd, L. Maccone, J. H. Shapiro, and H. P. Yuen, *Phys. Rev. Lett.* **92**, 027902 (2004).
- [21] C. E. Shannon, “Probability of error for optimal codes in a Gaussian channel,” *Bell Syst. Tech. J.*, **38**, 611 (1959).
- [22] R. G. Gallager, “Information Theory and Reliable Communication.”, New York: Wiley, (1968).
- [23] M. V. Burnashev and A. S. Holevo, *Probl. Peredachi Inf.*, vol.34, issue2, pp 3–15, (1998).
- [24] A. S. Holevo, “Reliability Function of General Classical-Quantum Channel”, *IEEE Trans. Inf. Th.*, **46**, No. 6, Sept. (2000).
- [25] M. Hayashi, “Error exponent in asymmetric quantum hypothesis testing and its application to classical-quantum channel coding”, *Phys. Rev. A* **76**, 062301 (2007).
- [26] M. Dalai, “Sphere Packing and Zero-Rate Bounds to the Reliability of Classical-Quantum Channels”, Proc. of IEEE Int. Symp. on Inf. Th. (ISIT 2012), Cambridge, MA, arXiv:1201.5411v1 [cs.IT] (2012).
- [27] J. H. Shapiro, *Physica Scripta* **T48**, 105 (1993).
- [28] G. M. D’Ariano, P. Lo Presti, and M. G. A. Paris, *Phys. Rev. Lett.* **87**, 270404 (2001).
- [29] A. Acín, *Phys. Rev. Lett.* **87**, 177901 (2001).
- [30] S. Aaronson and A. Arkhipov, “Computational complexity of linear optics”, STOC (2011), arXiv:1011.3245 (2011).
- [31] P. P. Rohde and T. C. Ralph, “Error tolerance of the boson-sampling model for linear optics quantum computing”, *Phys. Rev. A* **85**, 022332 (2012).